

TP2, 3, 4, 5

Electronic Programmable Room Thermostats Battery Powered (with voltage free contacts)

INSTALLATION & USER INSTRUCTIONS

TECHNICAL SPECIFICATION

Control Temperature Range	: 5-30°C
Power Supply	: 2 x AA/MN 1500/LR6 High Quality Alkaline Batteries
Switch Action	: 1 x SPDT, type 1B
Switch Rating	: 220/240Vac, 50/60Hz, 6(2)A
Temperature Accuracy	: ± 1°C
Timing Accuracy	: ± 1 min/month
Enclosure Rating	: IP20
Max. Ambient Temperature	: 45°C
Designed to meet BS EN60730-2-9	
Overall Dimensions	: 99 wide x 81mm high x 34 deep
Control Pollution Situation	: Degree 2
Rated Impulse Voltage	: 2.5Kv
Ball Pressure Test	: 75°C
Power Reserve	: 1 minute for battery change

This product complies with the following EC Directives:
Electro-Magnetic Compatibility Directive.
 (EMC) (89\336\EEC), (92\31\EEC)
Low Voltage Directive.
 (LVD) (73\23\EEC), (93\68\EEC)



FEATURES

- Controls central heating systems to provide different room temperatures up to 6 times a day.
- The TP3 and TP5 have one programme for Monday to Friday, with a different programme for Saturday and Sunday.
- TP2 and TP3 have minimum temperature setting of 16°C, ideal for use in elderly persons accommodation.
- Setting the TP4 and TP5 to the lowest temperature will effectively switch off the heating, whilst providing frost protection for the controlled area.*
- A constant low temperature is easily selected while away from home, for example, when on holiday.
- Battery operated. Ideal for low voltage control circuits, e.g. some combi-boilers, as well as for mains voltage circuits. Batteries can be changed without loss of programme.
- Wiring conversion chart for common room thermostats included.

* *This low temperature selection should not be used for Frost Protection if some parts of the heating system are in an exposed location.*

INSTALLATION INSTRUCTIONS

NEW INSTALLATION

Choose a fixing position where the thermostat will sense the room temperature without being affected by draughts or heat sources such as radiators, open fires or direct sunlight. Fix at height of approximately 1.5 metres from the floor.

Cable entry is from behind if fitted to a single gang flush box, or from above, below or from the left if surface fixed cable is used. Fig.1. shows fixing hole dimensions and the clearance required for the removal of the sliding cover, and for air flow over the sensor. Standard M3.5 screws are used to fix the thermostat to a flush box, or No.6 woodscrews and wall plugs of adequate length should be used for surface fixing.

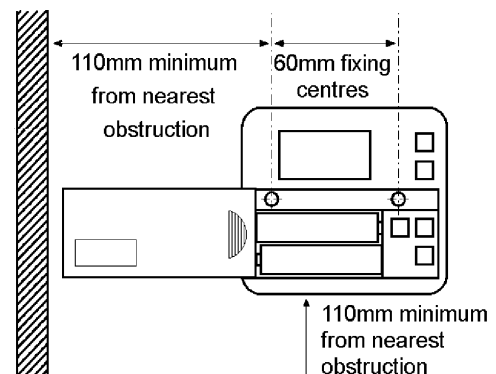

Fig.1. Fixing centre and clearances.

REPLACING AN ORDINARY ROOM THERMOSTAT

Switch OFF the power to the central heating system.

Carefully note which wire colours are connected to which terminal numbers of the existing thermostat.

If the existing thermostat has no indication of the numbers of each of its terminals then a qualified electrician should be called before proceeding any further.

Remove the existing thermostats mounting plate from the wall, and prepare the wall to receive the Programmable Room Thermostat. Refer to Fig.1. for dimensions. Connect the wires to the new thermostat referring to the wiring conversion chart overleaf.

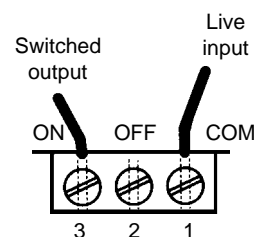

Fig.2. Terminals on rear of unit

NOTE:

Some existing thermostats will have a Neutral wire and/or an Earth wire connected. These wires must NOT be connected to the new terminals, but made electrically safe and coiled in the recess at the back of the new thermostat. If in any doubt about the function of every wire connected to the existing thermostat, call a qualified electrician for advice.

TYPICAL CIRCUIT DIAGRAMS

① ROOM STAT REPLACEMENT IN HEATSHARE SYSTEM

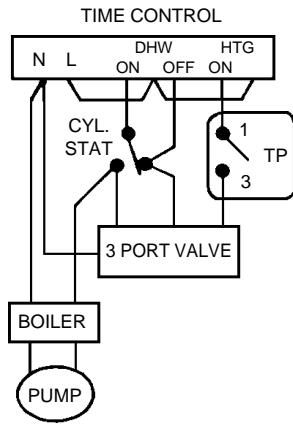

② ZONE CONTROL

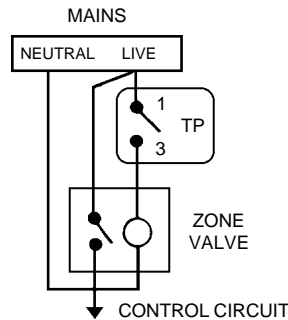

③ COMBI BOILER CONTROL

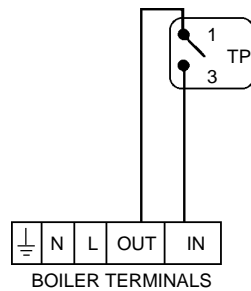

WIRING CONVERSIONS (see key to manufacturer below)

	ON	OFF	COM	N	⏏
TP2, 3, 4, 5	3	2	1	-	-
PET1 (P) TP1 (R)	1	2	L	N	⏏
CM5000 (H)	B	C	A	-	-
RD3, RD3A, (R)	2	-	1	4	-
R504 (R)	1	2	3	N	-
RTC, RTM (D) RSR/M (R)	1	2	3	N	⏏
RADI (L)	2	3	1	-	⏏
RTE (D)	2	3	1	4	-
T6060B, T6160B (H)	3	4	1	2	-

	ON	OFF	COM	N	⏏
TP2, 3, 4, 5	3	2	1	-	-
T4160B (H)	3	-	1	2	-
TLX 2259 (S)	1	-	3	4	⏏
TLX 2356 (S)	1	2	3	-	⏏
SRT2 (SW)	3	2	1	-	5
PRT1 (P)	H	-	L	N	-
PRT2 (P)	H	-	TL	N	-

(D) Drayton (R) Randall
 (H) Honeywell (S) Satchwell/Sunvic
 (L) Landis & Gyr (SO) Sopac
 (P) Potterton (SW) Switchmaster

USER INSTRUCTIONS

INITIAL START-UP

Slide the battery cover to the left to reveal the programming buttons. Slide the cover further left to reveal the batteries. Remove the paper insulator from between the batteries and contacts. Reset the unit as described below. The blank display changes to that shown in Fig.3. (if the actual air temperature in proximity of the unit is higher than 16°C the flame symbol will not be displayed. The day will only appear on models TP3 and TP5.) Slide the battery cover to the right but leave the buttons visible.



Fig.3. RUN mode

RESET

The unit may be reset to 12:00PM (MO) and the factory set programme by pressing and holding down the four buttons, temperature ▲ and ▼, time + and -, until the display goes blank.

SETTING THE CLOCK

Press the PROGRAMME button once; the colon is no longer flashing, (see Fig.4.). Use the + and - button to set the time. Hold down a button to change the time quickly; press and release a button to change the time by one minute. When the time and AM or PM are correct, press the PROGRAMME button to start the clock. On models TP2 and TP4 "Set Day" (Fig.5.) does not occur. If you have a TP3 or TP5, now only the day and the colon are on display, (Fig.5.). Use the + or - button to select the correct day. Press PROGRAMME to display the first setting (Fig.6.).

REVIEWING THE EXISTING SETTINGS AND PROGRAMMING YOUR OWN

Now each press of the PROGRAMME button shows, in, turn, the set times, (six with the TP2 and TP4, twelve with the TP3 and TP5), together with their associated control temperatures. Figs. 6 to 8 show the display of various settings in the sequence. The time and/or temperature of each setting may be altered to your own requirements using the + and - (time) and ▲ and ▼ (temperature) buttons.

Fig.4. Set time



Fig.5. Set day. TP3 & TP5 only.

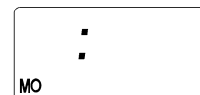

Fig.6. Setting 1.



Fig.7. Setting 2.



Fig.8. Last setting.



→ RUN

FACTORY PRE-SET PROGRAMMES

TP2, TP4 (Everyday)			TP3, TP5 (Saturday to Sunday)		
Setting	Time	Temp. °C	Setting	Time	Temp. °C
1	6:30am	20	1	7:00am	20
2	8:30am	16	2	10:00am	16
3	12:30pm	19	3	12:00pm	19
4	1:30pm	16	4	2:00pm	16
5	5:30pm	21	5	5:00pm	21
6	10:30pm	16	6	10:30pm	16

TYPICAL USER SET PROGRAMME

for models TP4 & TP5

Setting	Time	Temp. °C
1	6:00am	21
2	9:00am	5
3	12:30pm	5
4	1:30pm	5
5	4:00pm	21
6	10:00pm	5

This programme provides two heating periods, morning and evening and effectively switches the heating off during the day and overnight.

LIMITS OF ADJUSTMENT FOR TIME SETTINGS

Time setting 1 can be at any time of the day or night, but would normally be in the morning.

Each of the time settings 2 to 6 can be at any time between the preceding setting and 1.59am.

Time settings 2 to 5 can be set later than the next setting, but doing this changes the next setting as well...

....E.g. changing setting 2 in any of the above to 3.00pm would also change setting 3 and 4 to 3.00pm.

This feature prevents times being set out of sequence. If you wish to return to the pre-set programme reset the unit as described above.

EVERYDAY OPERATION

When all six or twelve time/temperature settings have been checked and/or altered, ensure the Programmable Room Thermostat is in the RUN mode with the colon blinking (see Fig.1.) before sliding the cover shut.

MANUAL OVERRIDE

If you wish to temporarily change the control temperature from the automatic setting, there is no need to re-programme the thermostat; just press the up or down button until the temperature you want is displayed. An up or down arrow will appear in the display (Fig.9.) to remind you that you have over-riden the programmed temperature. The unit will revert to programmed temperature at the start of the next programmed event.

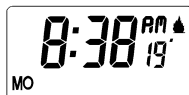

Fig.9.

CONSTANT LOW TEMPERATURE CONTROL

To set the thermostat to control at its low setting (5°C to 16°C depending on model) for 24 hours a day press both ▲ and ▼ buttons at the same time. The display will show the blinking colon, the low setting and the snowflake symbol (fig 10). To return to the automatic programme press the ▲ and ▼ buttons together again.

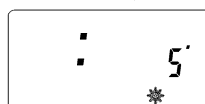

Fig.10.

BATTERY REPLACEMENT

When the batteries approach the end of their life, a battery symbol blinks in the display (Fig.10.). When this symbol appears both batteries should be replaced with high quality alkaline cells. 15 days after the battery symbol starts to blink, the thermostat will switch off. While the battery symbol is blinking the batteries may be changed without loss of time or programme.

Have the new batteries unwrapped and ready, slide the battery cover fully off to the left, remove the old batteries and insert the new ones WITHIN ONE MINUTE. Replace and slide close the battery cover. The thermostat will continue to function according to the automatic programme. Should the display ever go blank during normal operation the batteries will need to be renewed, the unit reset, and the time (and day) and programmes reset if required.



Fig.11.



Danfoss Randall can accept no responsibility for possible errors in catalogues, brochures and other printed material, and reserves the right to alter its products without notice. This also applies to products already on order provided that such alterations can be made without subsequent changes being necessary in specifications already agreed.

Danfoss Randall Limited

Amphill Road
Bedford
MK42 9ER
Tel: (01234) 364621 Fax: (01234) 271474
Email: danfosrandall@danfoss.com
Website: www.danfoss-randall.co.uk